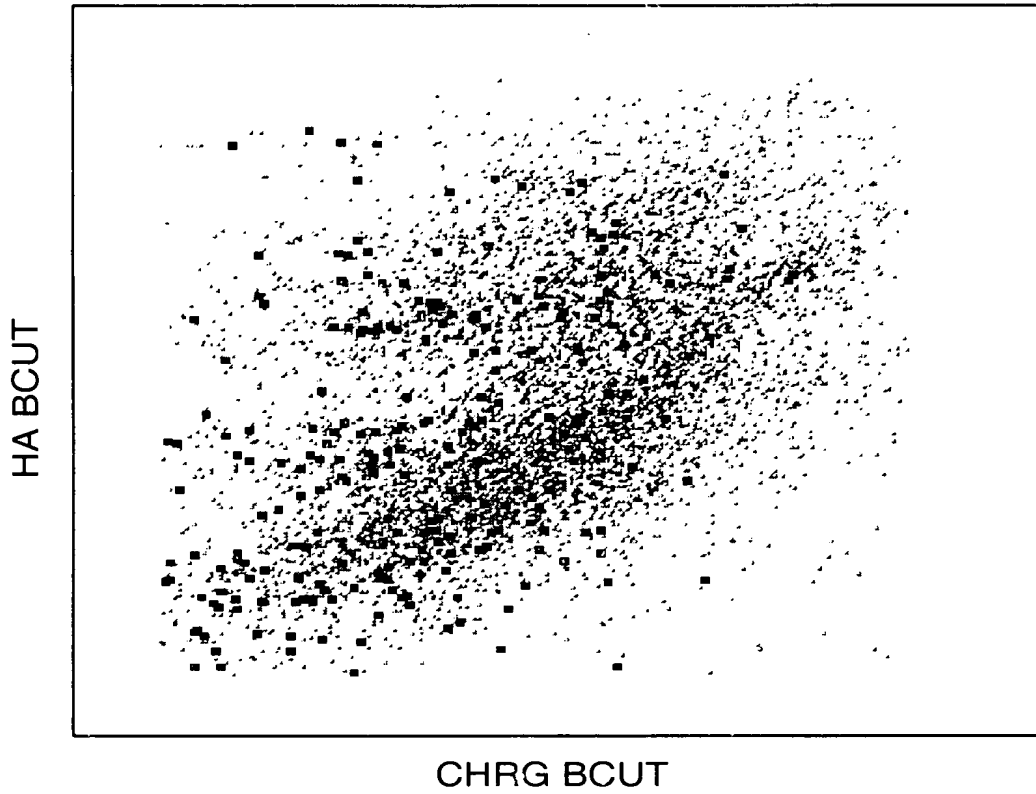


Fig. 1

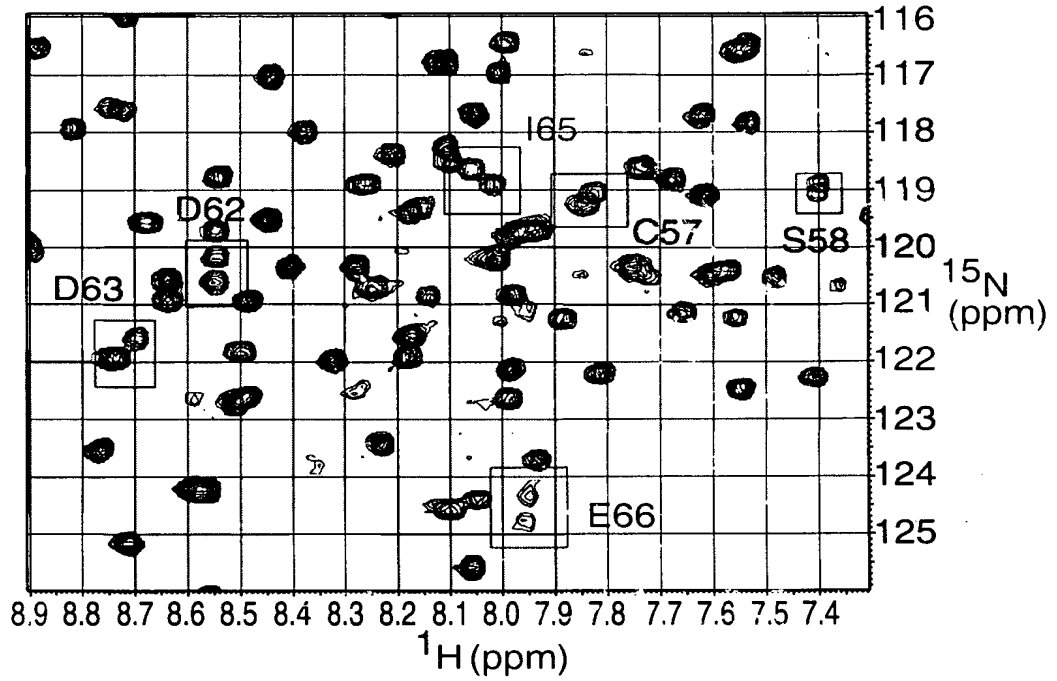
2/17



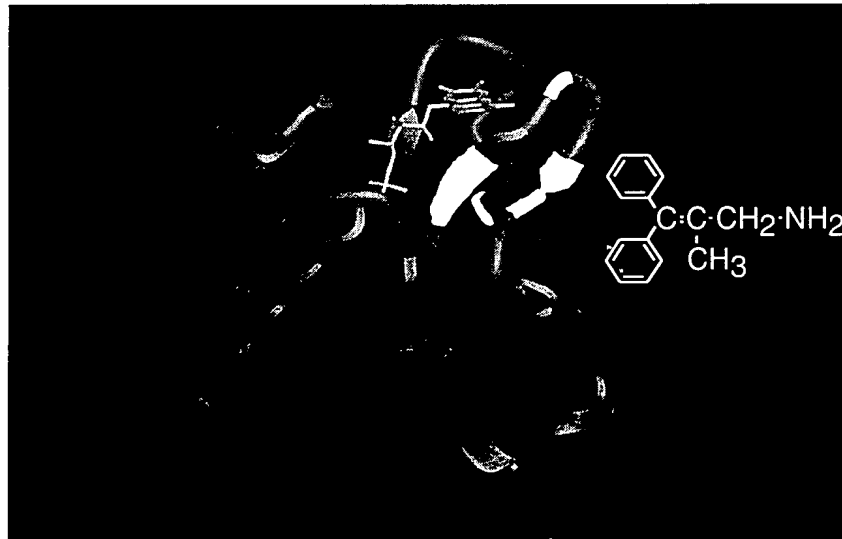
**Fig. 2**



4/17

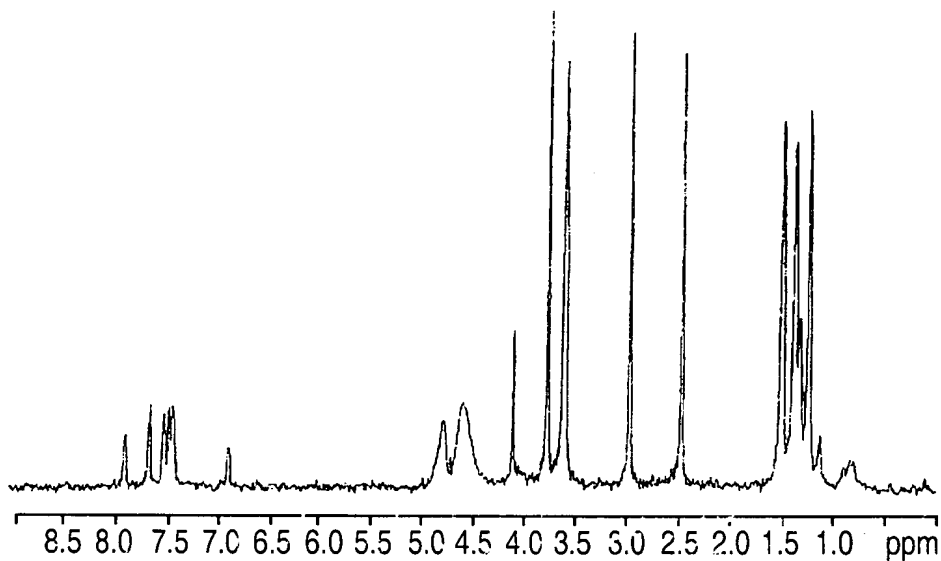


**Fig. 4A**

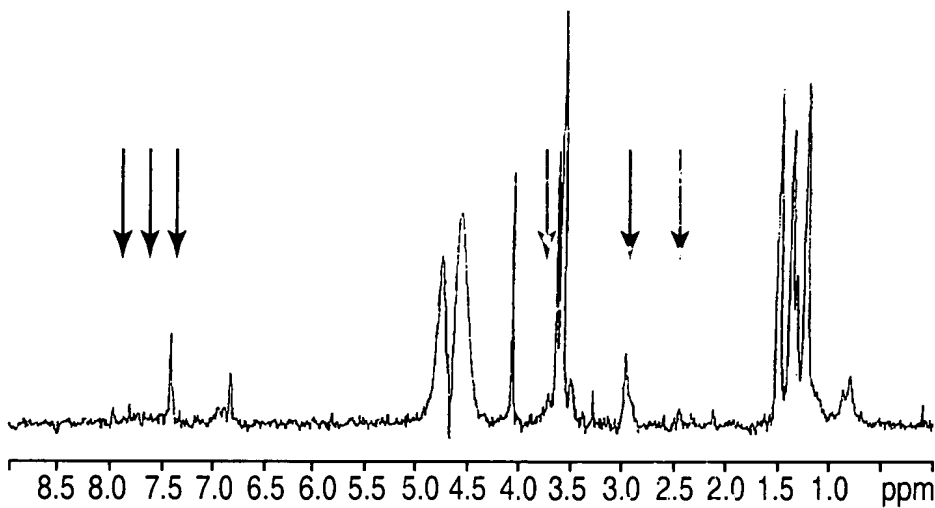


**Fig. 4B**

5/17



**Fig. 5A**



**Fig. 5B**

6/17

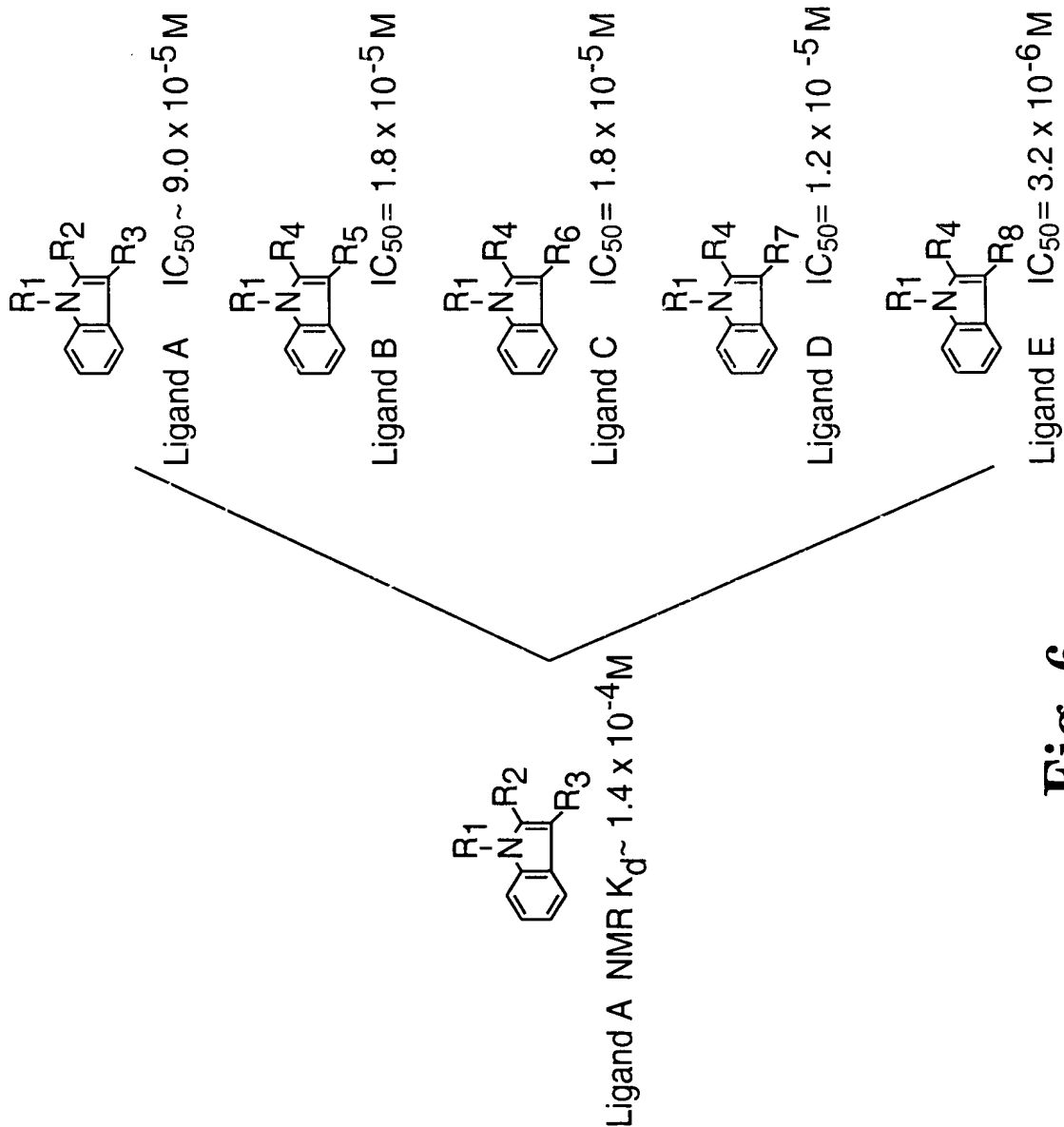
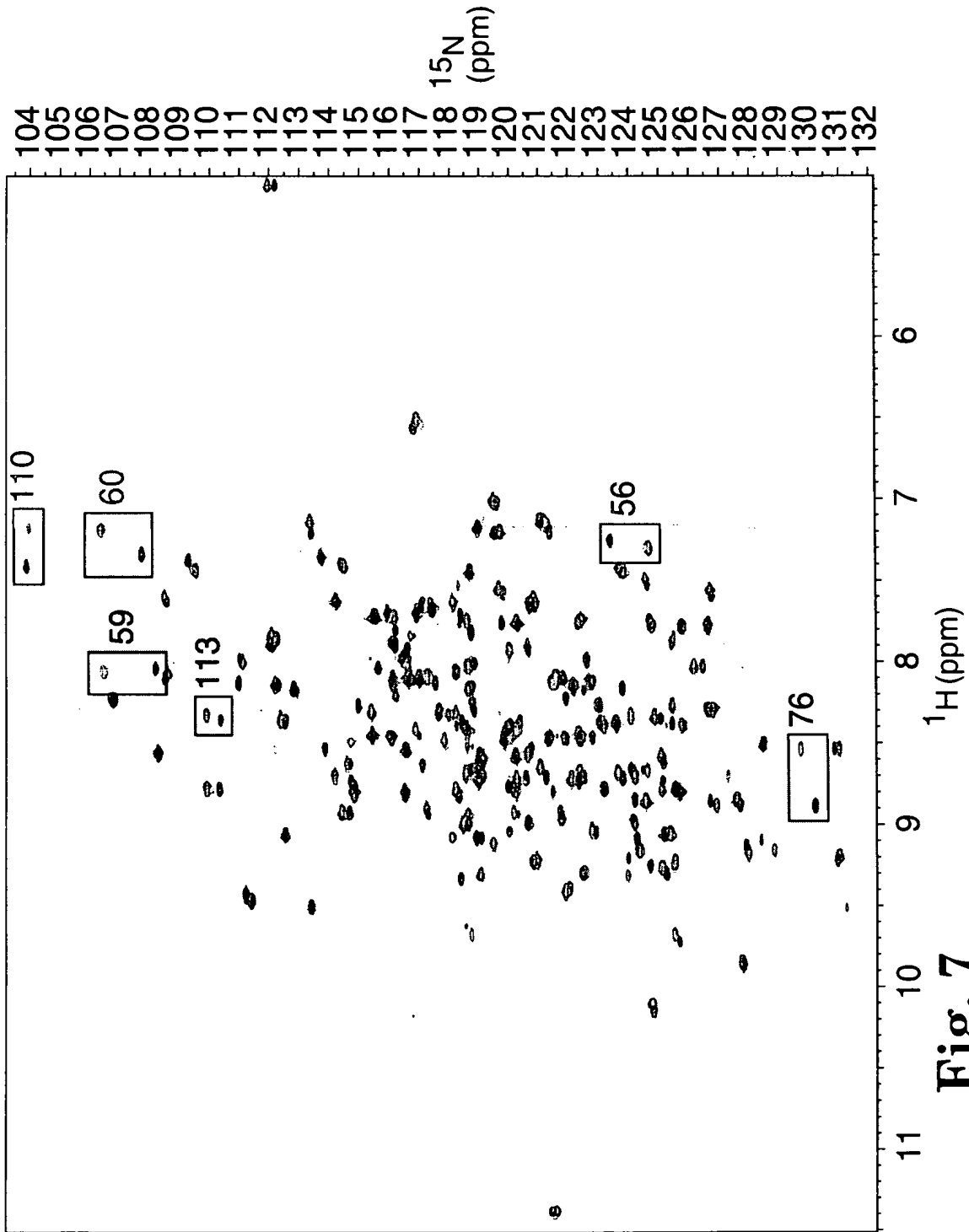


Fig. 6

7/17







9/17

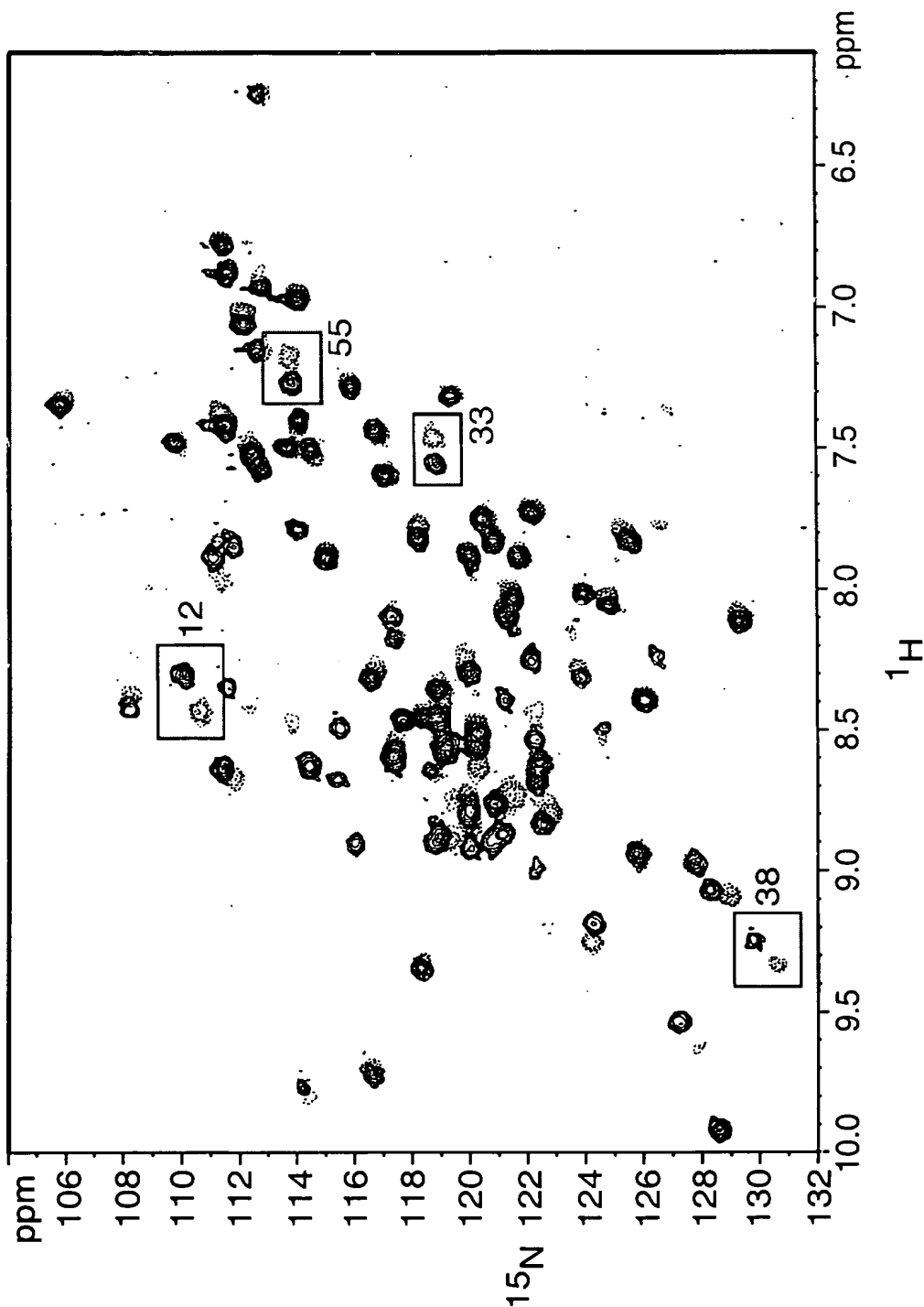


Fig. 9

10/17

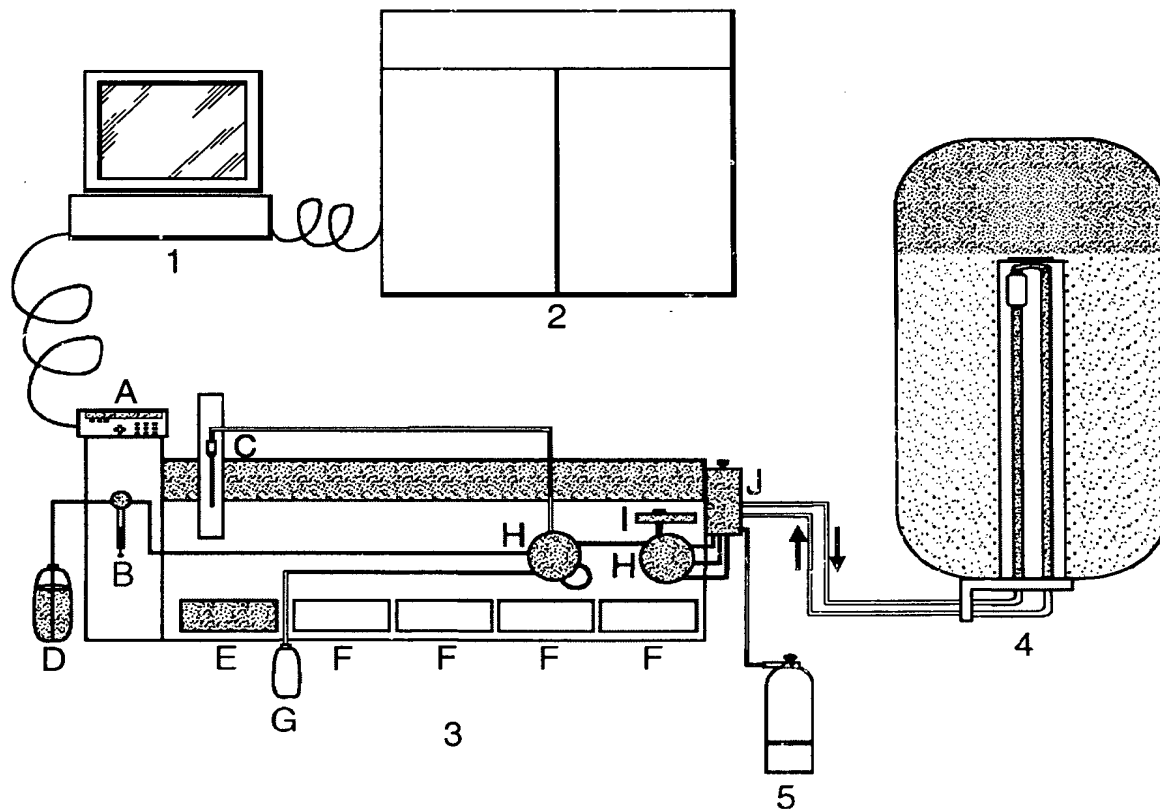


Fig. 10

11/17

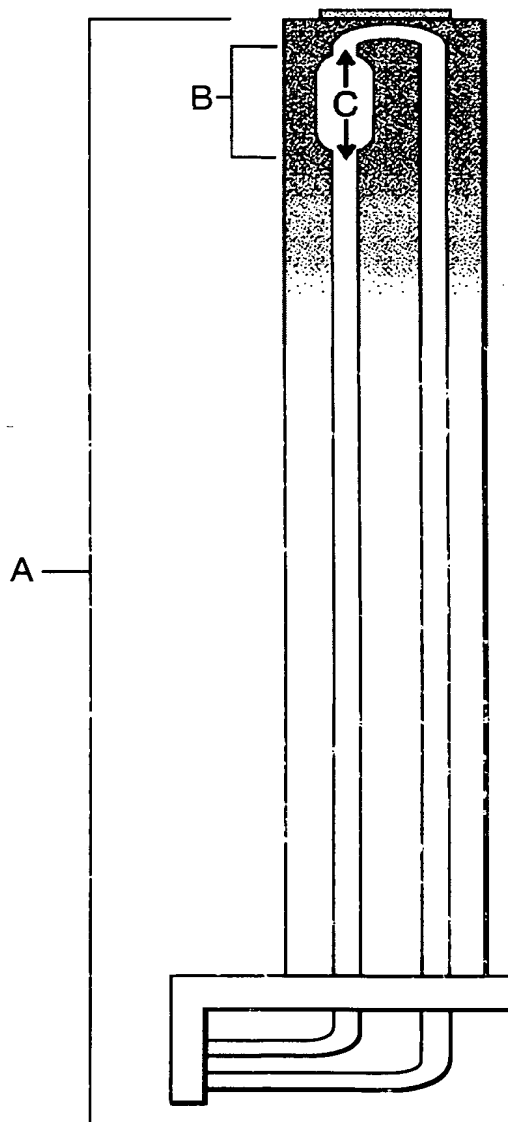
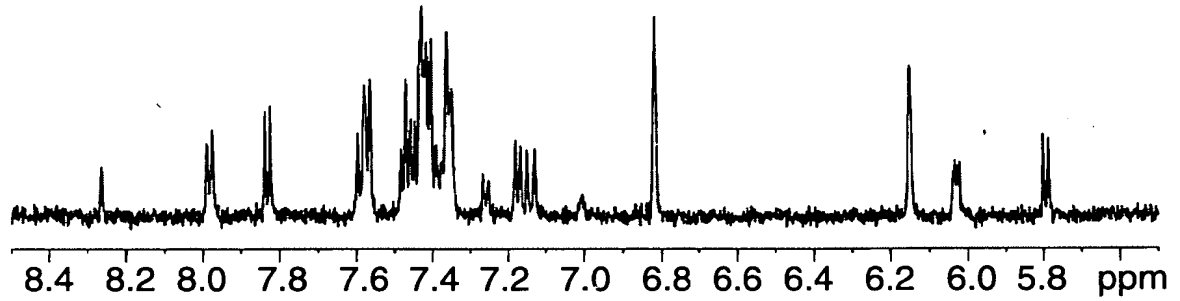
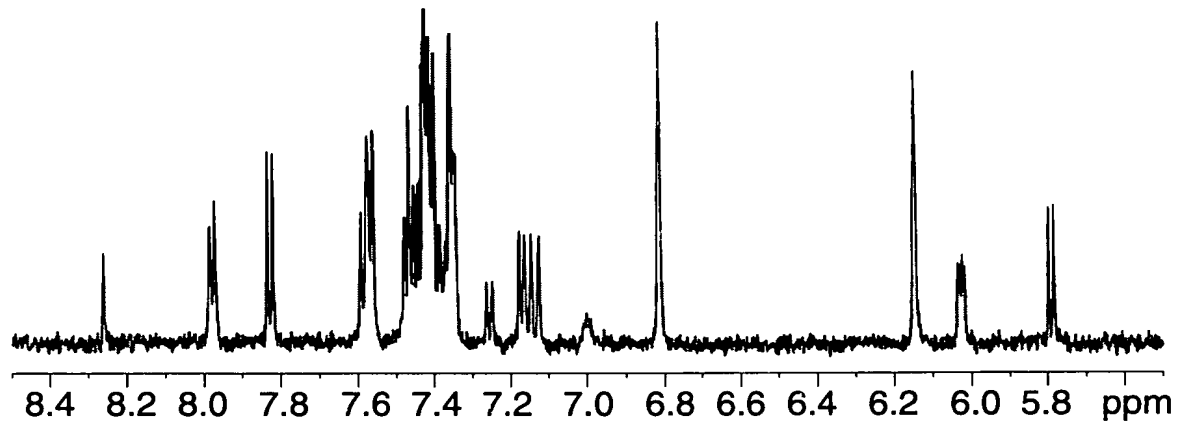


Fig. 11

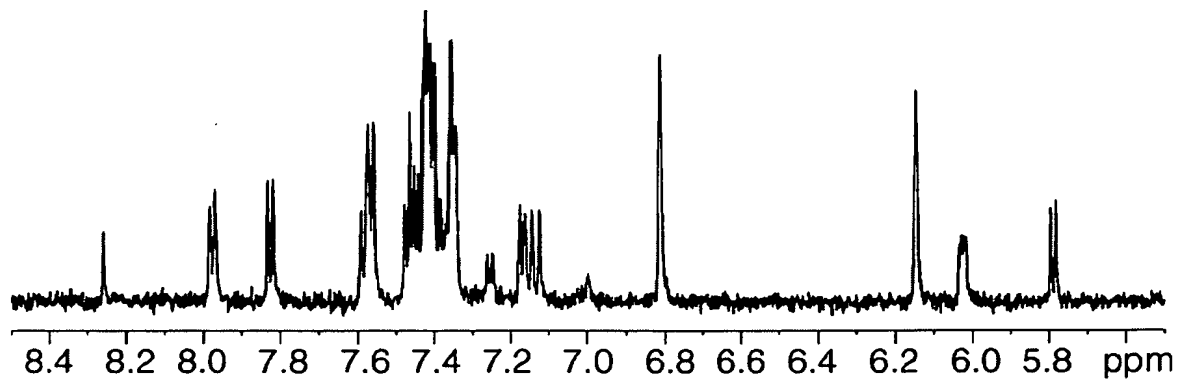
12/17



**Fig. 12A**

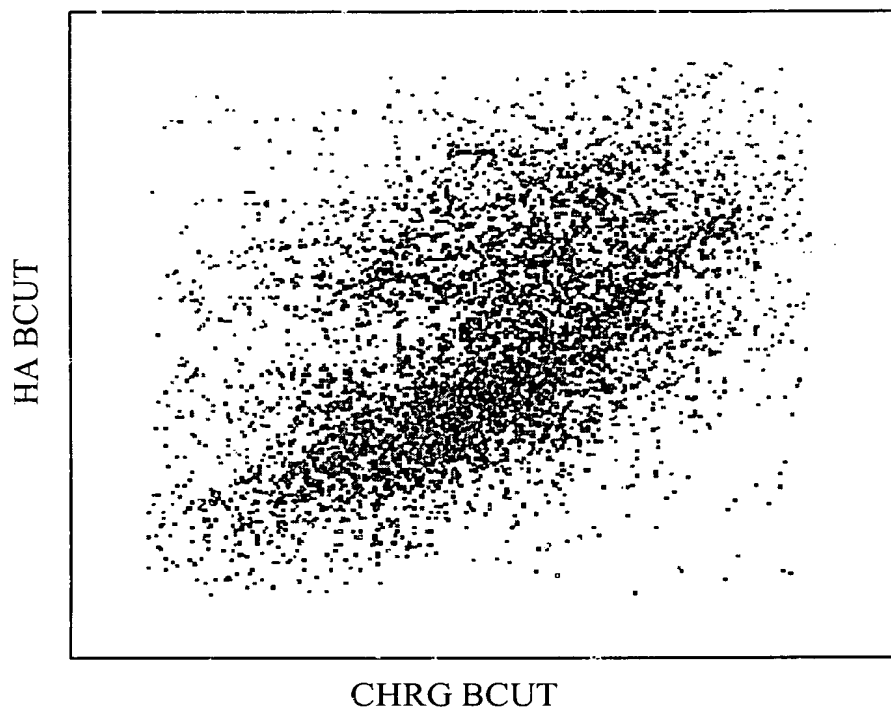


**Fig. 12B**



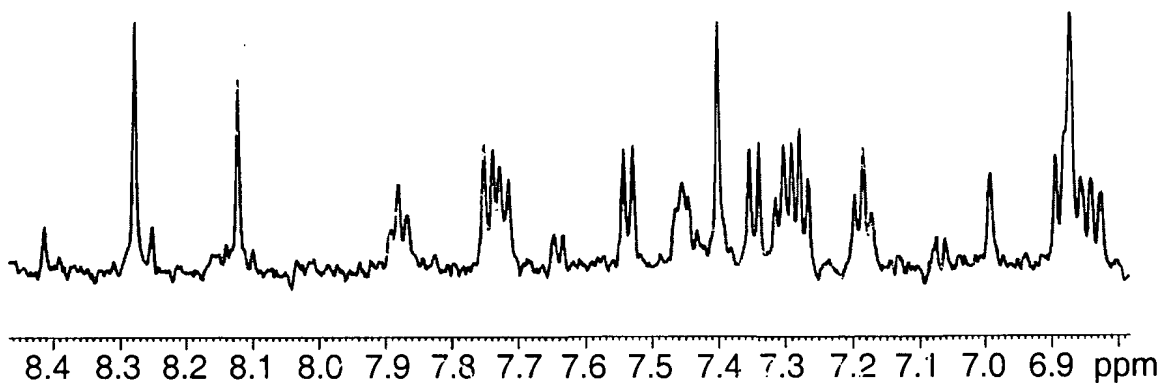
**Fig. 12C**

13/17

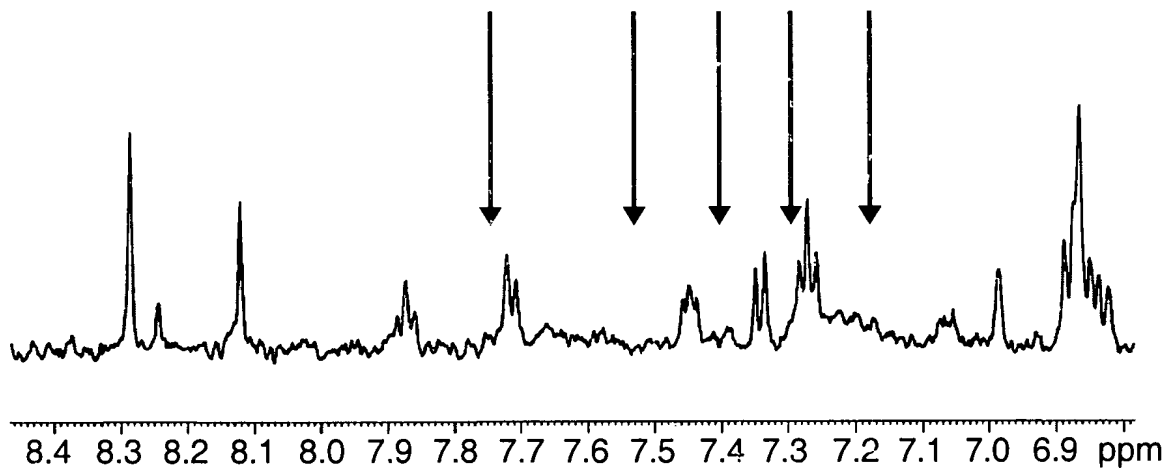


**Fig. 13**

14/17

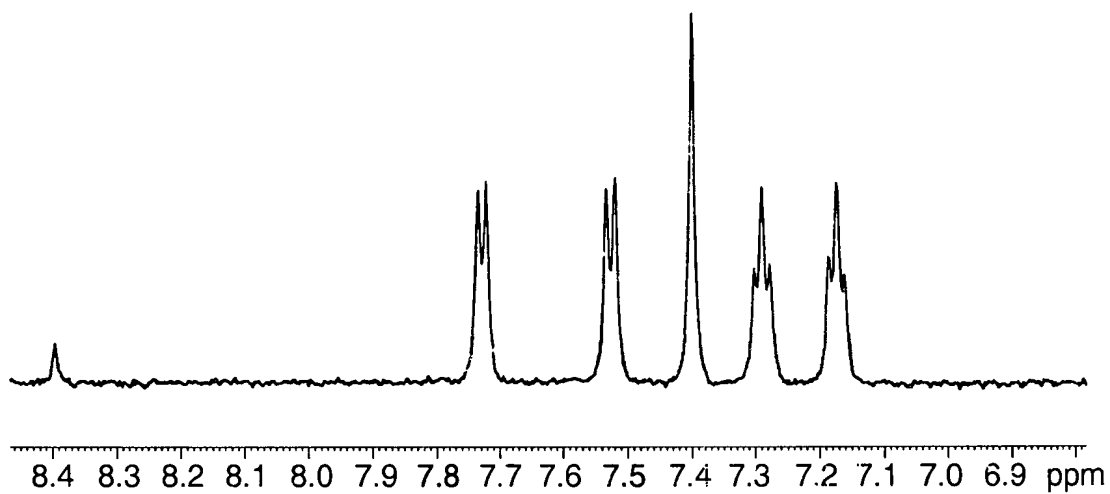


**Fig. 14A**

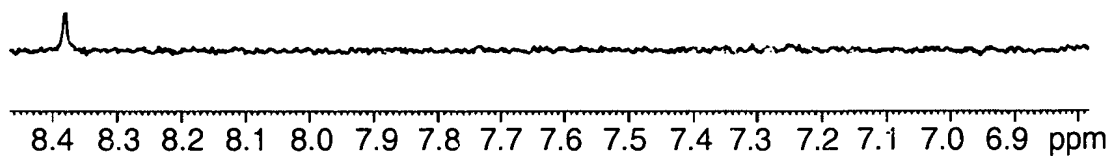


**Fig. 14B**

15/17

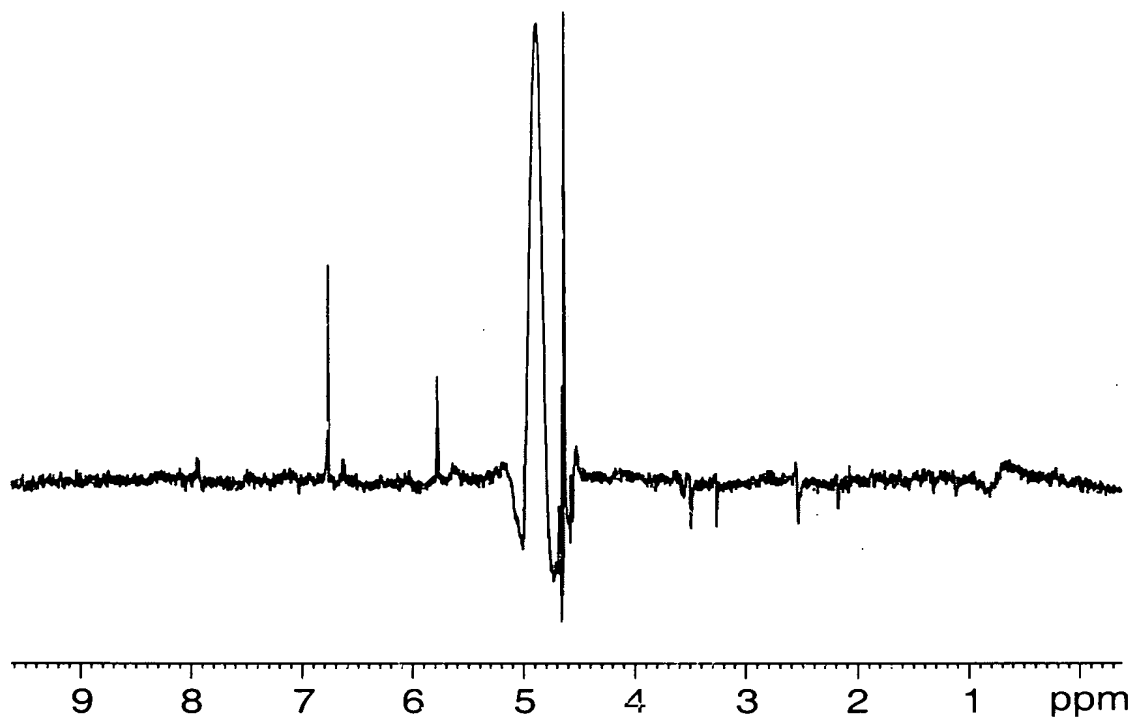


**Fig. 15A**



**Fig. 15B**

16/17



**Fig. 16**



17/17

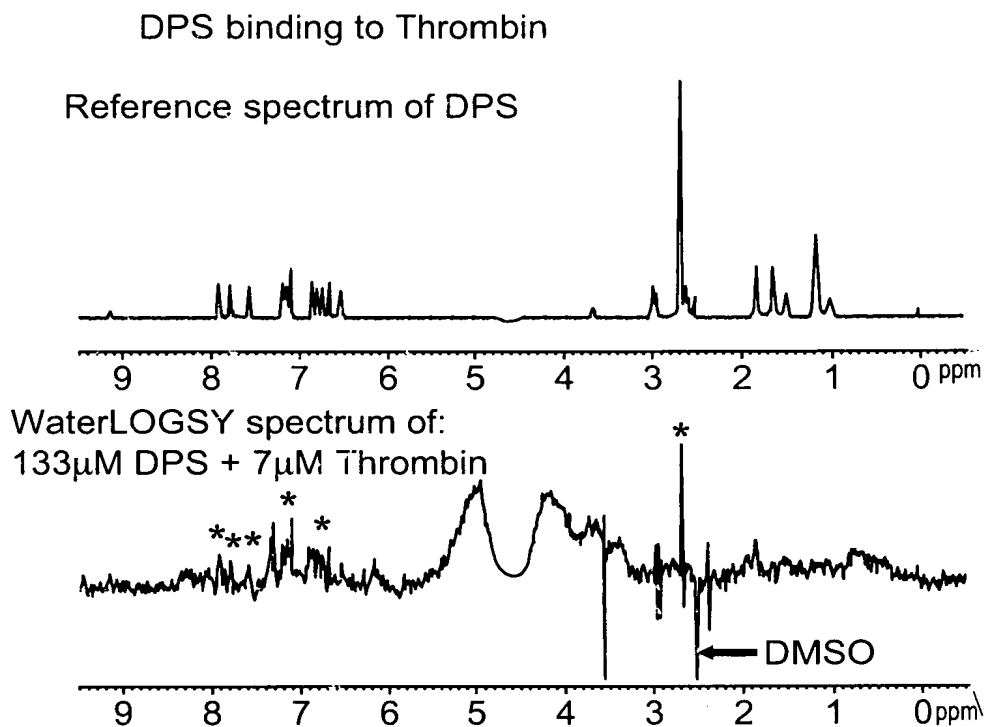


Fig. 17